



User and installation Manual

Wired Controller with weekly timer

Thank you for choosing commercial air conditioners. Please read this Owner' s Manual carefully before operation and retain it for future reference.

To Users

Please read this instruction manual carefully before installing and using the product, so as to master and correctly use the product. In order to guide you to correctly install and use our product and achieve expected operating effect, we hereby instruct as below:

- (1) This appliance is not intended for use by persons (including children) with reduced physical, sensory or mental capabilities, or lack of experience and knowledge, unless they have been given supervision or instruction concerning use of the appliance by a person responsible for their safety. Children should be supervised to ensure that they do not play with the appliance.
- (2) This instruction manual is a universal manual, some functions are only applicable to particular product. All the illustrations and information in the instruction manual are only for reference, and control interface should be subject to actual operation.
- (3) In order to make the product better, we will continuously conduct improvement and innovation. We have the right to make necessary revision to the product from time to time due to the reason of sales or production, and reserve the right to revise the contents without further notice.
- (4) For personal injury or property loss and damage caused by improper operation such as improper installation and debugging, unnecessary maintenance, violation of related national laws and rules and industrial standard, and violation of this instruction manual, etc., we will bear no liability.
- (5) The final right to interpret for this instruction manual belongs to ArgoClima.





Contents

1 Safety Notices (Please be sure to abide)	1
2 Display.....	2
2.1 Appearance	2
2.2 Instructions for Related Displayed Symbols	3
3 Buttons	6
3.1 Button Graphics.....	6
3.2 Function Instructions of Buttons	7
4 Operation Instructions	7
4.1 Menu Structure.....	7
4.2 On/Off	9
4.3 Mode Setting	10
4.4 Temperature Setting	11
4.5 Fan Setting.....	11
4.6 Swing Setting.....	11
4.7 Functions Setting	12
4.7.1 Fresh Air Function Setting.....	16
4.7.2 Sleep Function Setting.....	18
4.7.3 Health Function Setting.....	18
4.7.4 I-DEMAND Function Setting.....	18
4.7.5 Holiday Function Setting	18
4.7.6 Memory Function Setting.....	19
4.7.7 Save Function Setting.....	19

4.7.8 Auxiliary Heating Function Setting	20
4.7.9 Dry Function Setting	20
4.7.10 Filter Clean Reminder Setting	20
4.7.11 Quiet Function Setting	21
4.7.12 Fahrenheit Temperature Setting	21
4.7.13 Fixed-angle Swing Mode Setting	21
4.7.14 Low-temperature Drying Function Setting	21
4.7.15 WiFi Function Setting	22
4.7.16 SETBACK Function Setting	22
4.7.17 Independent Swing Function Setting	22
4.7.18 Panel Lifting Function Setting	23
4.7.19 Language Setting	24
4.8 Unit Status View	24
4.9 Current Error View	26
4.10 Timer Setting	28
4.10.1 One Time Clock Timer	28
4.10.2 Daily Timer	29
4.10.3 Weekly Timer	30
4.10.4 Two Week Timer	33
4.10.5 Countdown Timer	34
4.11 Clock Setting	36
4.11.1 Time Format Setting	36
4.11.2 Clock Setting	37
4.12 Lock Setting	39

5 Installation Instructions	40
5.1 Parts and Dimension of Wired Controller	40
5.2 Installation Requirements	41
5.3 Installation Methods	42
5.4 Disassembly	43

1 Safety Notices (Please be sure to abide)

	Warning: If not abide strictly, it may cause severe damage to the unit or the people.
	Note: If not abide strictly, it may cause slight or medium damage to the unit or the people.
	This sign indicates that the operation must be prohibited. Improper operation may cause severe damage or death to people.
	This sign indicates that the items must be observed. Improper operation may cause damage to people or property.















WARNING!













This product can't be installed at corrosive, inflammable or explosive environment or the place with special requirements, such as kitchen. Otherwise, it will affect the normal operation or shorten the service life of the unit, or even cause fire hazard or serious injury. As for above special places, please adopt special product with anti-corrosive or anti-explosion function.

2.2 Instructions for Related Displayed Symbols



Table 2.2.1 Instructions for Related Displayed Symbols

No.	Symbols	Instructions
1		Up and down swing function
2		Left and right swing function
3		Fresh air function
4		Sleep function
5		Auto mode
6		Cooling mode
7		Dry mode
8		Fan mode
9		Heating mode
10		Health function
11		I-Demand function
12		Holiday function
13		Shielding status (Buttons, temperature, ON/OFF, mode or energy saving is shielded by remote monitor)

Wired Controller

No.	Symbols	Instructions
14		Current set fan speed
15		Memory function (Memory in power failure)
16		Save function
17		Dry function
18		Remind to clean the filter
19		Timer on status
20		Gate card pulled-off status or nobody presented status
21		Quiet function
22		Function lock
23		WiFi is turned on
24		Independent swing is turned on
25		Setback function is turned on

Wired Controller

No.	Symbols	Instructions
26		Auxiliary heating status
27		Display of set temperature: the temperature shown in the diagrams of this manual is in Fahrenheit scale(°F). Temperature display in Fahrenheit scale and Celsius scale can be selected. Please refer to the setting by the user.

3 Buttons

3.1 Button Graphics

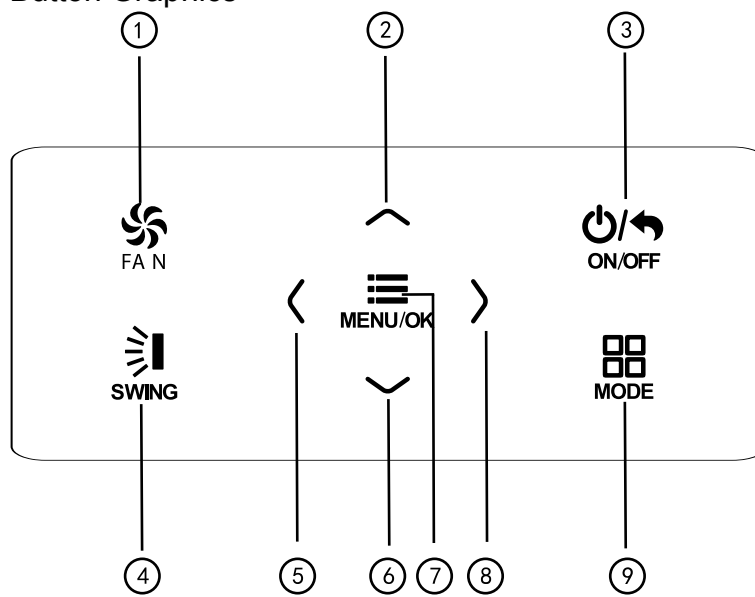

Figure 3-1 Button graphics

3.2 Function Instructions of Buttons

Table 3.2.1 Function Instructions of Buttons

No.	Button name	Button Function
1	FAN	Set low speed, low-medium speed, medium speed, medium-high speed, high speed, turbo and auto speed.
2	^	(1) Set temperature (2) Set parameter (3) Move option cursor
6	v	
3	ON/OFF	(1) Turn on or turn off unit (2) Return to previous page
4	SWING	Set up&down swing and set left&right swing
5	<	(1) Set related function on or off (2) Move option cursor (3) Set parameter
8	>	
7	MENU/OK	(1) Enter menu page (2) Confirm setting
9	MODE	Set auto, cooling, dry, fan and heating modes for indoor unit.

4 Operation Instructions

4.1 Menu Structure

Normal setting of wired controller can be set directly on the main page, including fan speed, swing, set temperature, mode, ON/OFF. The setting and status view of

Wired Controller

other functions can be set in corresponding submenu. Detailed menu structure is as shown in the Fig. as below.

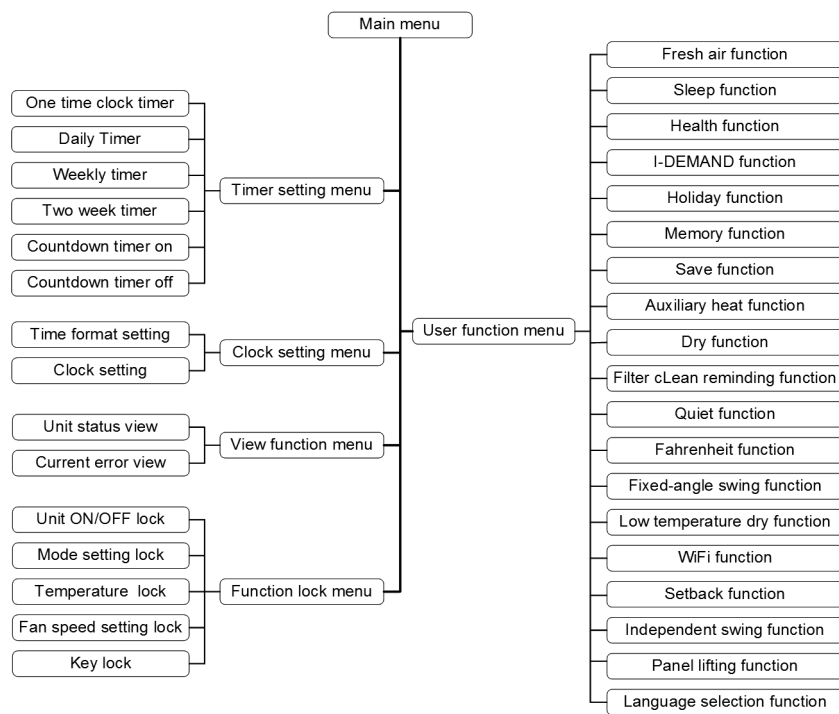

Figure 4-1 Menu structure

4.2 On/Off

When the wired control is on main page, press “ON/OFF” button to turn on the unit. Press “ON/OFF” button again to turn off the unit. The interfaces of On/Off status are shown in the Fig. as below.

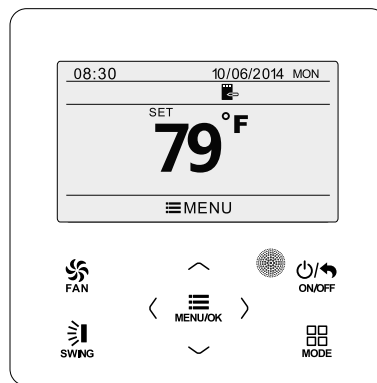

Figure 4-2 Unit off page

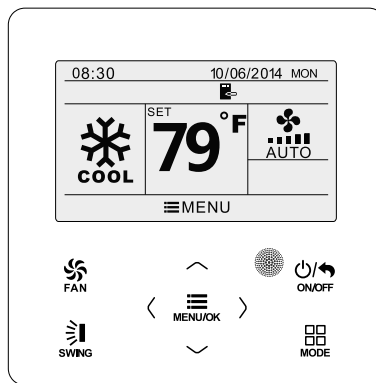

Figure 4-3 Unit on page

4.3 Mode Setting

Under on status, press “MODE” button on the main page can set mode circularly as below.

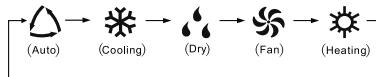

Figure 4-4 Mode Setting

Note :

- (1) If save function is turned on, auto mode is not available.
- (2) Heating mode is not available for the cooling only unit.

4.4 Temperature Setting

Under on status, press “^” or “v” button on the main page to increase or decrease set temperature by 1°C(1°F); hold “^” or “v” button to increase or decrease set temperature by 1°C(1°F) every 0.3s.

In cooling, dry, fan and heating mode, temperature setting range is 16°C~30°C (61°F ~ 86°F). There are two circumstances under auto mode: (1) temperature can be set and the setting range is 16°C ~ 30°C (61°F ~ 86°F) ; (2) temperature can't be set. It depends on the unit model.

4.5 Fan Setting

Under on status, press “FAN” button can set fan speed circularly as below.
 Low→Medium low→Medium→Medium high→High→Turbo→Auto→Low
 Symbols displayed are as shown in the Fig.as below.



Figure 4-5 Fan Setting

4.6 Swing Setting

Under on status, press “SWING” button for swing setting. Two swing modes are available: fixed-angle swing and simple swing.

Fixed-angle swing: when fixed-angle swing mode is set, swing operation is as follows:

Under on status,press “SWING” button to select up&down swing ,,then press “SWING” button, Up&down swing angle will be adjusted circularly as below:

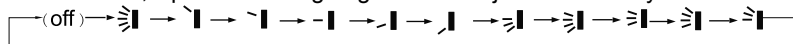

Figure 4-6 up&down swing

Wired Controller

Select up&down swing and left&right swing through “<” or “>” button. When left&right swing is selected. Left&right swing angle will be adjusted circularly as below:

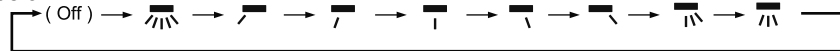

Figure 4-7 left&right swing

Note :

- (1) Turn on fixed-angle swing mode in function setting page.
- (2) If fixed-angle swing is not available for the model, fixed-angle swing will be invalid when the wired controller turns on fixed-angle swing mode.

Simple swing mode: when fixed-angle swing mode is turned off, swing operation is as below:

Under on status, press “SWING” button and the focus frame will appear. Press “<” or “>” button to select up&down swing or left&right swing. Press SWING button to turn on or turn off up&down swing or left&right swing. Swing icon will be displayed when swing function is turned on. Otherwise, swing icon will not be displayed.

4.7 Functions Setting

Press “MENU/OK” button on main page to enter main menu page. Press “<” or “>” button to select the function setting symbol. Then press “MENU/OK” button to enter user function setting page. Press “^” or “v” button to select specific function item. Press “<” or “>” button to turn on or turn off this function, or enter into the next step setting of the function by pressing “MENU/OK” button. If the function is displayed in grey, it indicates this function item can't be set under current mode or off status. The operation is shown in the Fig.as below.

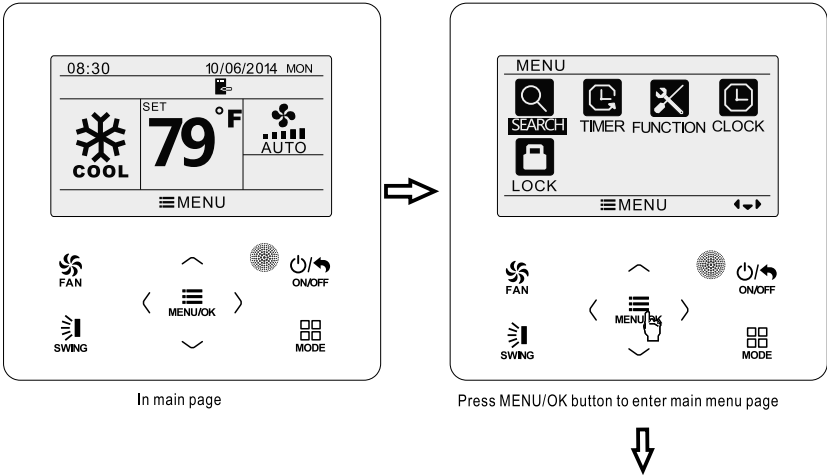

Wired Controller

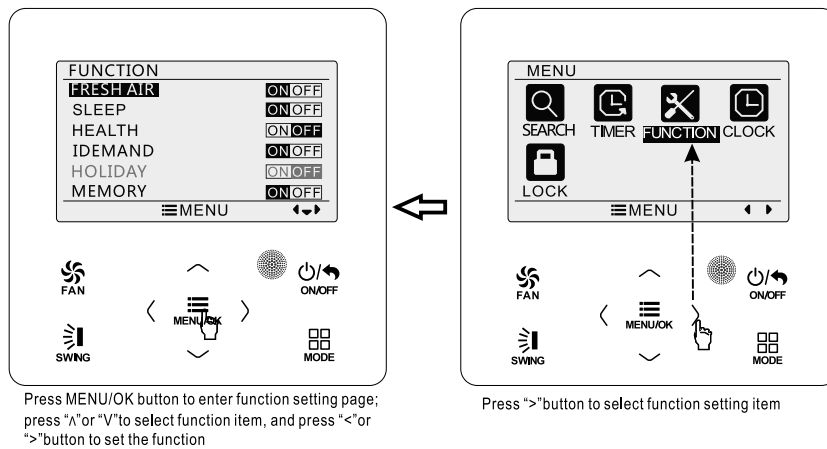

Figure 4-8 Function setting

Function introduction is shown in the table as below.

Table 4.7.1 Function introduction

Function	Instruction
Fresh air function	Adjust indoor fresh air volume to improve air quality and keep indoor air fresh. (The unit needs to be installed with a new damper).
Sleep function	The indoor unit enters a sleep state and operates according to a preset sleep temperature curve to create a comfortable sleeping environment and improve sleep quality.
Health function	Generate negative ions to ensure that the health.

Wired Controller

Function	Instruction
I-Demand function	Unit will operate under save mode to save energy.
Holiday function	In the heating mode, when the user goes out, it is used to maintain the indoor ambient temperature to ensure turbo heating when the user comes back.
Memory function	When the power is restored after power failure, the indoor unit resumes the original status.
Save function	Set the lower limit of set temperature for cooling and dry mode and set the upper limit of set temperature for heating mode to let the air conditioner operate in a smaller temperature range for saving energy.
Auxiliary Heating function	In the heating mode, auxiliary heat function is started up to improve the heating efficiency.
Dry function	It used to blow off the moisture of the indoor unit's evaporator after shutdown to avoid mold. The drying function can only be turned on under the cooling or dry mode.
Filter clean reminder function	The air conditioning unit will record its own running time. When the user set time is reached, it will remind the user to clean the filter, so as to avoid problems such as poor cooling and heating effect, abnormal protection and bacterial growth.
Quiet function	Decrease the noise of the indoor unit and achieve the mute effect.

Wired Controller

Function	Instruction
Fixed-angle swing mode	Switch between simple swing and fixed-angle swing to satisfy user's requirement.
Low-temperature drying function	The unit runs the dry mode at a lower set temperature to improve the drying capacity.
Setback function	After shutdown, the unit will automatically run to ensure that the indoor ambient temperature is within the set temperature range.
Independent swing function	It can set the swing mode with 4 swing air outlets to satisfy the users in different air outlet directions.
Panel lifting function	The panel can come down to let the user to clean the filter.

4.7.1 Fresh Air Function Setting

Under on status, after entering into user function page, press “^” or “v” button to select fresh air function and press “<” or “>” button to turn on or turn off air function. Press “MENU/OK” button to enter into the setting page of fresh air mode.

After entering into the setting page of fresh air, press “^” or “v” button to adjust the mode. There are 10 setting modes. Once setting is finished, press “MENU/OK” button to save the setting.

Table 4.7.2 Mode Instruction

Mode	Instruction
1	The unit continuously runs for 60min, and fresh air valve runs for 6 min.
2	The unit continuously runs for 60min, and fresh air valve runs for 12 min.
3	The unit continuously runs for 60min, and fresh air valve runs for 18 min.
4	The unit continuously runs for 60min, and fresh air valve runs for 24 min.
5	The unit continuously runs for 60min, and fresh air valve runs for 30 min.
6	The unit continuously runs for 60min, and fresh air valve runs for 36 min.
7	The unit continuously runs for 60min, and fresh air valve runs for 42 min.
8	The unit continuously runs for 60min, and fresh air valve runs for 48 min.
9	The unit continuously runs for 60min, and fresh air valve runs for 54 min.
10	All on

4.7.2 Sleep Function Setting

Under on status, after entering into user function page, press “Λ” or “V” button to select sleep function and press “<” or “>” button to turn on or turn off sleep function with auto saving.

Note :

- (1) Under fan or auto mode, sleep function is not available.
- (2) Sleep function will be canceled when turning off the unit or switching mode.

4.7.3 Health Function Setting

Under on status, after entering into user function page, press “Λ” or “V” button to select health function and press “<” or “>” button to turn on or turn off health function with auto saving.

4.7.4 I-DEMAND Function Setting

Under on status, after entering into user function page, press “Λ” or “V” button to select IDEMAND function option and press “<” or “>” button to turn on or turn off this function with auto saving.

Note :

- (1) This function is only available in cooling mode.
- (2) When this function has been set, fan speed setting will be shielded.
- (3) This function will be cancelled when turning off the unit or switching modes.
- (4) This function and sleep function cannot be turned on simultaneously. If I-demand function is set firstly and then sleep function is set, I-demand function will be cancelled while sleep function will be valid, and vice versa.

4.7.5 Holiday Function Setting

Under on status, after entering into user function page, press “Λ” or “V” button to

select holiday function option and press “<” or “>” button to turn on or turn off this function with auto saving.

Note :

- (1) This function is only available in heating mode.
- (2) When this function has been set, set temperature is displayed in 8°C(46°F). In this case, temperature setting and fan speed setting are shielded.
- (3) This function will be cancelled when switching modes.
- (4) This function and sleep function cannot be on simultaneously. If this function is set firstly and then sleep function is set, it will be cancelled while sleep function will be valid, and vice versa.

4.7.6 Memory Function Setting

After entering into user function page, press “^” or “v” button to select memory function and press “<” or “>” button to turn on or turn off memory function with auto saving.

4.7.7 Save Function Setting

Under on status, after entering into user function page, press “^” or “v” button to select save function and press “<” or “>” button to turn on or turn off save function. Press “MENU/OK” button to enter save function setting page.

After entering save function setting page, press “<” or “>” button to select cooling or heating limitation temperature. After that, press “^” or “v” button to adjust limitation temperature value. Once setting is finished, press “MENU/OK” button to save the setting.

Note :

When save function has been set, auto mode cannot be set.

4.7.8 Auxiliary Heating Function Setting

Under on status, after entering into user function page, press “^” or “v” button to select auxiliary heating function and press “<” or “>” button to turn on or turn off this function with auto saving.

Note :

This function can be set only in heating mode.

4.7.9 Dry Function Setting

Under on status, after entering into user function page, press “^” or “v” button to select dry function and press “<” or “>” button to turn on or turn off this function with auto saving.

Note :

This function can be set only in cooling and dry mode.

4.7.10 Filter Clean Reminder Setting

After entering into user function page, press “^” or “v” button to select filter clean function and press “<” or “>” button to turn on or turn off this function. Press “MENU/OK” button to enter the setting page of filter clean reminder function.

After entering the setting page of filter clean reminder function, press “^” or “v” button to select pollution level and then press “<” or “>” button to set pollution level; press “^” or “v” button to select accumulating time setting and then press “<” or “>” button to set required time. Once setting is finished, press “MENU/OK” button to save the setting.

When level 1 is selected, the adjusting range of accumulating operating time is 5,500~10,000 hours, with 500 hours in each increase or decrease.

When level 2 is selected, the adjusting range of accumulating operating time is 1,400~5,000 hours, with 400 hours in each increase or decrease.

When level 3 is selected, the adjusting range of accumulating operating time is 100~1,000 hours, with 100 hours in each increase or decrease.

Whenever you turn off this function, the unit's operating time will be zero clearing.

4.7.11 Quiet Function Setting

Under on status, after entering into user function page, press “Λ” or “V” button to select quiet function and press “<” or “>” button to turn on or turn off this function with auto saving.

Note :

(1) This function is only available in cooling mode, heating mode and auto mode.

4.7.12 Fahrenheit Temperature Setting

After entering into user function page, press “Λ” or “V” button to select Fahrenheit temperature function and press “<” or “>” button to turn on or turn off this function with auto saving. Once this function is turned off, Celsius temperature will be displayed.

4.7.13 Fixed-angle Swing Mode Setting

After entering into user function page, press “Λ” or “V” button to select fixed-angle swing function and press “<” or “>” button to turn on or turn off this function with auto saving.

Note :

If fixed-angle swing function is not available for the connected unit, this function will be cancelled automatically after setting.

4.7.14 Low-temperature Drying Function Setting

Under on status, after entering into user function page, press “Λ” or “V” button to

select low-temperature drying function and press “<” or “>” button to turn on or turn off this function with auto saving.

Note :

- (1) This function is only available in dry mode.
- (2) When low-temperature drying function is turned on, the displayed set temperature in dry mode is 12°C(54°F). This function will be off automatically after readjusting set temperature.

4.7.15 WiFi Function Setting

After entering into user function page, press “^” or “v” button to select WiFi function and press “<” or “>” button to turn on or turn off this function. Press “MENU/OK” button to enter into WiFi reset page.

Once it enters into WIFI reset setting page, press “<” or “>” button to select reset or not. After that, press “MENU/OK” button to confirm it.

4.7.16 SETBACK Function Setting

After entering into user function page, press “^” or “v” button to select SETBACK function and press “<” or “>” button to turn on or turn off this function. Press “MENU/OK” button to enter into SETBACK function setting page.

Once it has entered into SETBACK function setting page, press “<” or “>” button to select upper or lower limit temperature; Press “^” or “v” button to adjust the limit temperature value. After that, press “MENU/OK” button to save setting.

4.7.17 Independent Swing Function Setting

Under on status, after entering into user function page, press “^” or “v” button to select the independent swing function. Press “MENU/OK” button to enter into independent swing function setting page.

Press “^” or “v” button can select independent swing setting, reset independent swing and view independent swing setting list. After that, press “MENU/OK” button to enter into corresponding item setting page.

(1) Once it have entered into independent swing setting page, press “^” or “v” button to select the air outlet (there are four air outlet on the panel marked by the circles. The number is 1, 2, 3 and 4. The number of “0” of air outlet is corresponding to the number of circles of air outlet on the panel) and then press “<” or “>” button to turn on or turn off the independent swing function for this air outlet . Press “MENU/OK” button can set the detailed swing mode for this air outlet. Press “^” or “v” button to set the detailed mode. The swing mode is circulating according to the sequence in the Fig. as below. Once setting is finished, press“MENU/OK” button to save it.

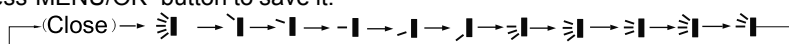

Figure 4-9 swing setting

(2) Once it has entered into the setting page of reset independent swing, press “<” or “>” button to select whether reset independent swing or not. Once selection is finished, press “MENU/OK” button to confirm it. If select to reset independent swing, the independent swing function of all air outlets will be turned off.

(3) Once it has entered into the independent swing setting list page, on/off status of independent swing function and swing mode for each air outlet can be viewed.

Note :

- (1) Only up&down swing is available for independent swing function.
- (2) Only one air outlet at the most can be closed for the independent swing.
- (3) Turn off independent swing function can resume to original up&down swing setting.

4.7.18 Panel Lifting Function Setting

Under on status, after entering into user function page, press “^” or “v” button to select panel lifting function. Press “MENU/OK” button to enter into the panel lifting

Wired Controller

function setting page. Press “^” or “v” button to control the up, down or stop for the panel.

Press “ON/OFF” button to reset the panel. The reset window is displayed, which indicates the reset is processing. Once the panel reset is finished, it will resume to the main page automatically.

Note:

- (1) Once it has entered into the function, operation mode will be switched to the fan mode.
- (2) Because the panel lifting is realized by changing the set temperature, if press “^” or “v” button continuously, it will reach to the limit value. At this time, press the button in the opposite direction consecutively to control it again.
- (3) Once panel reset is finished, the unit is at off status.

4.7.19 Language Setting

After entering into user function page, press “^” or “v” button to select language setting. Press “MENU/OK” button to enter into language setting page. Press “^” or “v” button to select your required language and then press “MENU/OK” button to save the setting.

4.8 Unit Status View

Press “MENU/OK” button to enter into the menu and select the function symbol to be viewed. Then press “MENU/OK” button to enter view function page. Press “^” or “v” button to select status view function. Press “MENU/OK” button to enter unit status view page. Press “ON/OFF” button to return to the previous page. Please refer to the Fig. as below.

Wired Controller

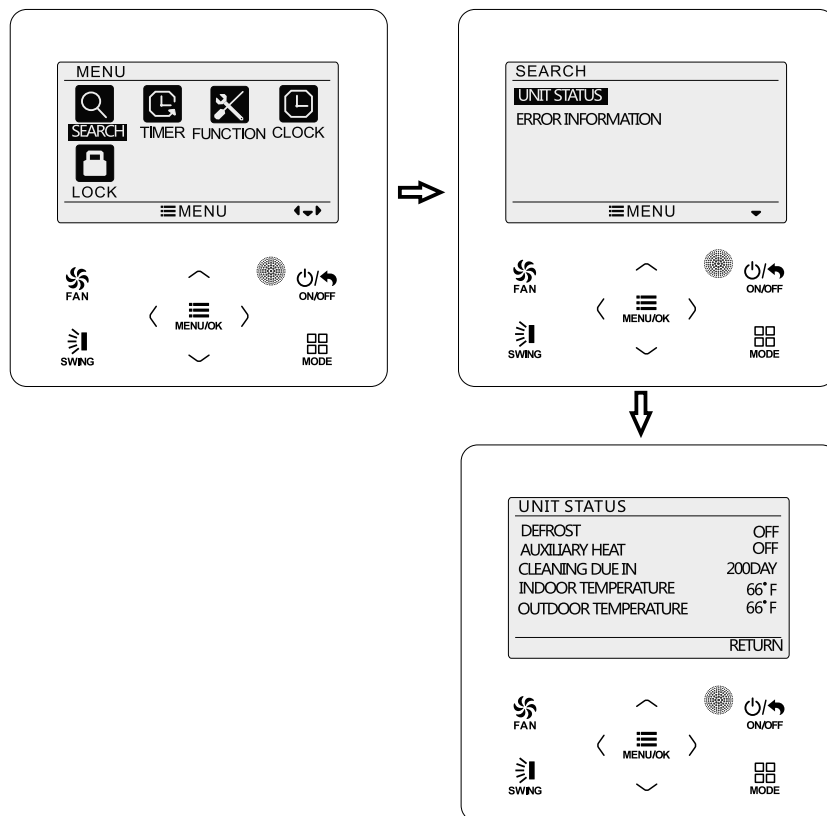

Figure 4-10 Status View

Wired Controller

The following statuses can be viewed: if defrosting is operating; if auxiliary heating is operating; residual time of filter cleaning reminder; indoor ambient temperature; outdoor ambient temperature.

Note :

- (1) The residual time of filter cleaning reminder is valid only when the cleaning reminder function is turned on.
- (2) If there isn't outdoor ambient temperature sensor for the unit or the sensor detection hasn't started to work, the outdoor ambient temperature view parameter is invalid.

4.9 Current Error View

When error occurs in the unit, error symbol will be displayed on the main page of wired controller. In this case, you can enter error view page to view the current error.

Press "MENU/OK" button to enter the menu and select the function symbol to be viewed. Then press "MENU/OK" button to enter view function page. Press "Λ" or "v" button to select error information. Press "MENU/OK" button to enter error information page. When there are many errors, press "Λ" or "v" to turn pages. Press "ON/OFF" button to return to the previous page. Please see the Fig. as below.

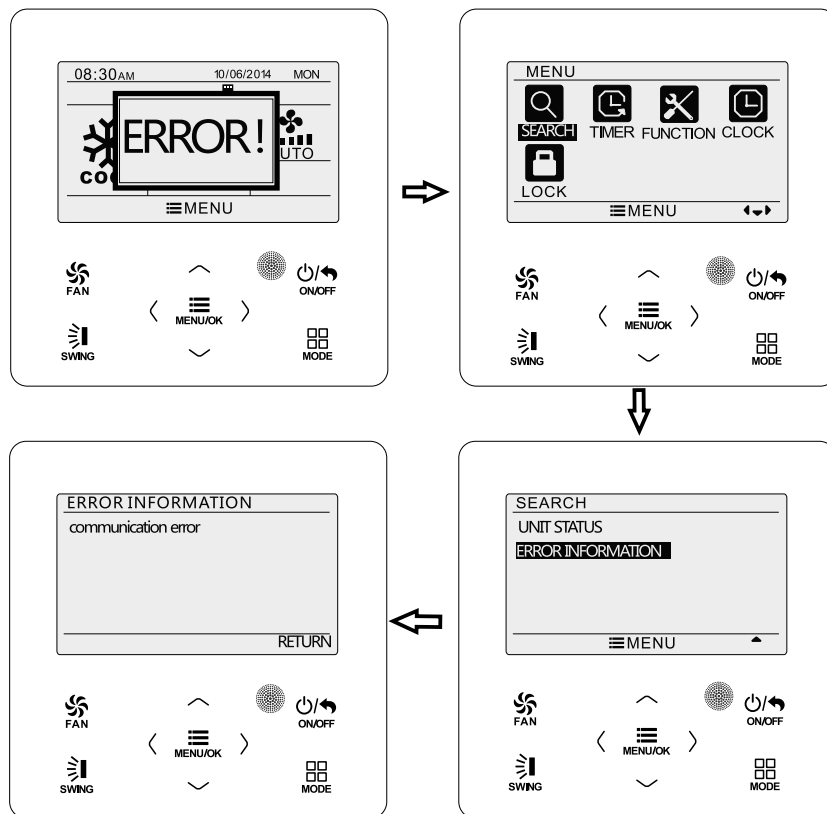

Figure 4-11 Current Error View

4.10 Timer Setting

The wired controller can set 6 kinds of timer: one time clock timer, everyday timer, one week timer, two week timer, countdown timer on and countdown timer off. Select timer symbol after entering menu page. Press "MENU/OK" button to enter timer setting page. Press "▲" or "▼" button to select one kind of timer. Press "<" or ">" button to turn on or turn off this timer. Please refer to the Fig. as below.

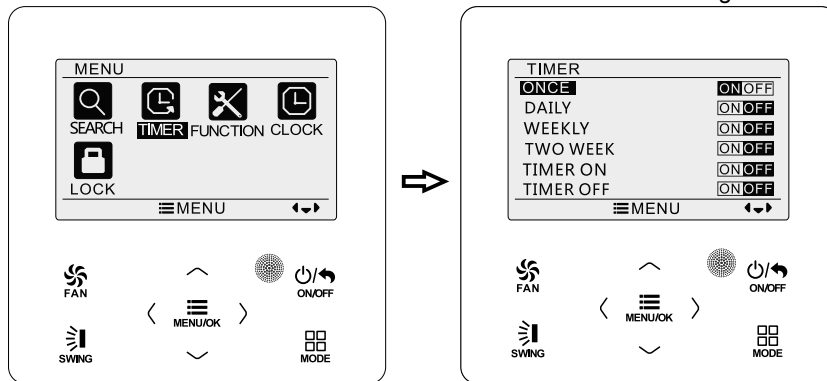

Figure 4-12 Turn on or turn off timer

4.10.1 One Time Clock Timer

The wired controller can set one time clock timer. Timer on can be set when the unit is under off status. Timer off can be set when the unit is under on status. This timer will be carried out for only once when timer time is reached and then the timer will be off automatically.

In timer function setting page, when one time timer is selected, press "<" or ">"

button to turn on or turn off it. Press “MENU/OK” button to enter timer time setting page. Please refer to the Fig. as below.

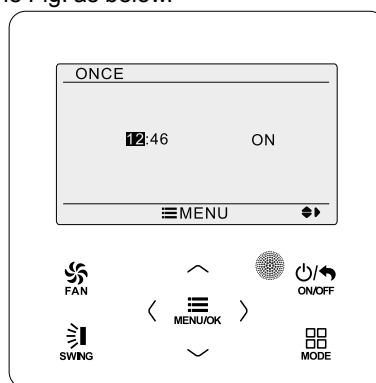

Figure 4-13 one time clock timer

Press “<” or “>” button to select timer hour or minute and press “^” or “v” button to adjust time. Holding “^” or “v” button increases or decreases time rapidly. Once setting is finished, press “MENU/OK” button to save timer time.

Note:

- (1) If this timer function is turned on, when the unit is turned on or turned off, this timer function will be cancelled automatically.

4.10.2 Daily Timer

In daily timer, user can set eight segments of timer individually. The individual segment will be valid only when it is turned on. In each segment, you can set time, unit ON/OFF, set temperature in cooling (it is valid only when the current mode is

Wired Controller

cooling), set temperature in heating (it is valid only when the current mode is heating). Please refer to the Fig. as below.

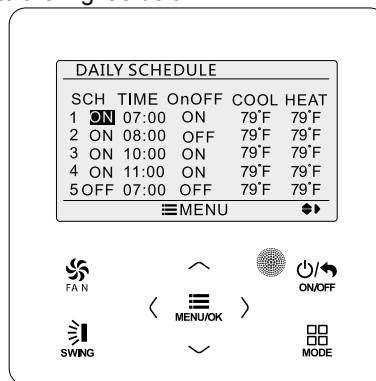

Figure 4-14 Daily timer setting

After entering daily timer setting page, press “<” or “>” button to select setting item. Press “^” or “v” button to adjust the value. Press “MENU/OK” button to save setting.

4.10.3 Weekly Timer

The user can set the everyday timer content for a week. In each day, the user can set eight segments of timer content. The unit will execute corresponding timer setting in a week.

After entering weekly timer setting page, press “<” or “>” button to select the day to be set. Then press “MENU/OK” button to enter timer programming of that day. Press “<” or “>” button to select the item to be set. Press “^” or “v” button to adjust the content. Press “MENU/OK” button to save setting. Please refer to the Fig. as below.

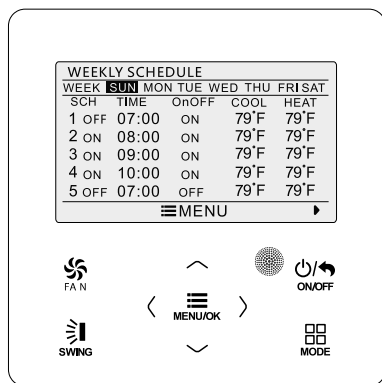

Enter weekly timer schedule setting page

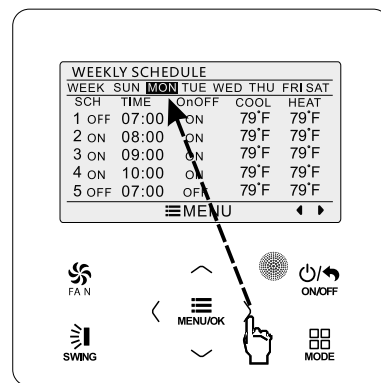

Press “<” or “>” button to select the day to be set



Wired Controller

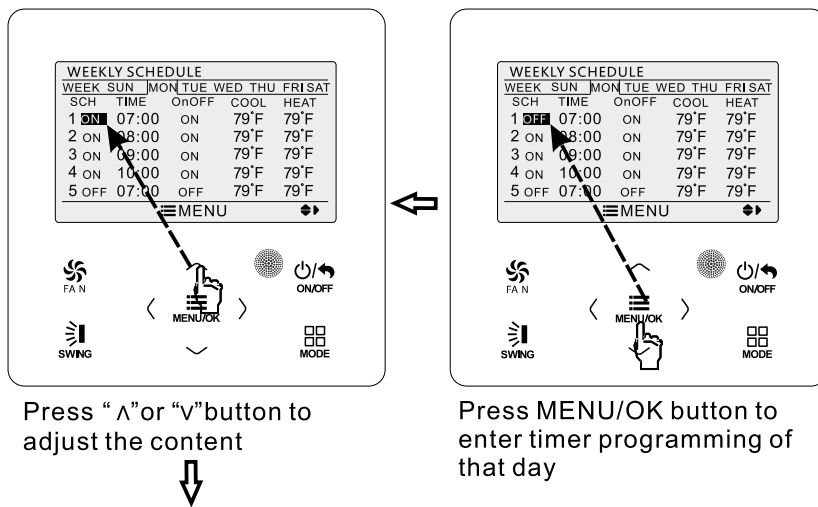

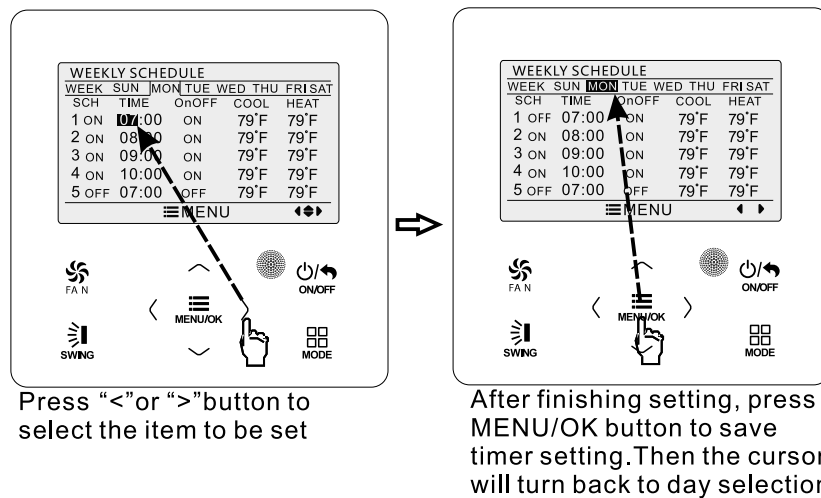

Figure 4-15 Weekly timer setting

4.10.4 Two Week Timer

The user can set the everyday timer content for two weeks. In each day, the user can set eight segments of timer content. The unit will execute corresponding timer setting in two weeks.

In the timer setting page, press “^” or “v” button to select two week timer setting and then press “MENU/OK” button to enter two week timer menu page. Press “^”

Wired Controller

or “V” button to select current week and then press “<” or “>” button to set current week as first week or second week. Please refer to the Fig. as below.

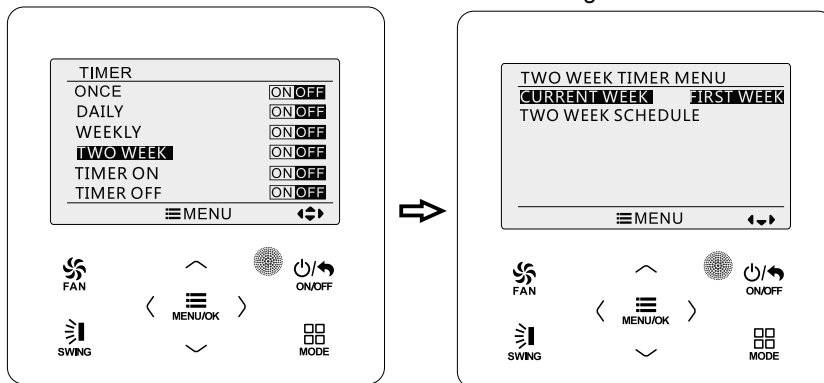

Figure 4-16 Setting of current week

After entering two week timer menu page, press “^” or “v” button to select the two week schedule and then press “MENU/OK” button to enter two week timer programming. After entering two week timer setting page, press “<” or “>” button to select the day to be set. Then press “MENU/OK” button to enter timer programming of that day. Press “<” or “>” button to select the item to be set. Press “^” or “v” button to adjust the content. Press “MENU/OK” button to save setting. Press “ON/OFF” button to exit this page. Please refer to weekly timer setting for symbols setting.

4.10.5 Countdown Timer

Countdown timer includes timer on and timer off. Unit On/Off after a desired hour can be set. Under on status, timer off can be set, or timer off and timer on can be set simultaneously. Under off status, timer on can be set, or timer off and timer

on can be set simultaneously. If timer off in “x” hours and timer on in “y” hours are set simultaneously in unit on status, the unit will be off in “x” hours and then the unit will be on in “y” hours after timer off.

After entering into timer on setting page, press “^” or “v” button to increases or decreases time by 0.5h. Press “ON/OFF” button to return to the previous page. Please refer to the Fig. as below.

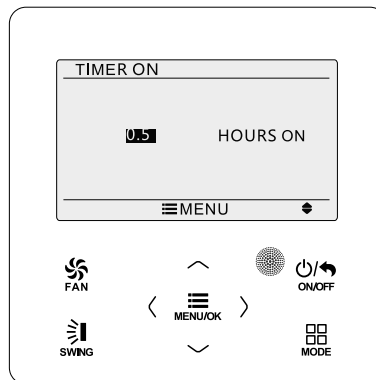

Figure 4-17 Countdown timer on

After entering into timer off setting page, press “^” or “v” button to increases or

Wired Controller

decreases time by 0.5h. Press "ON/OFF" button to return to the previous page. Please refer to the Fig. as below.

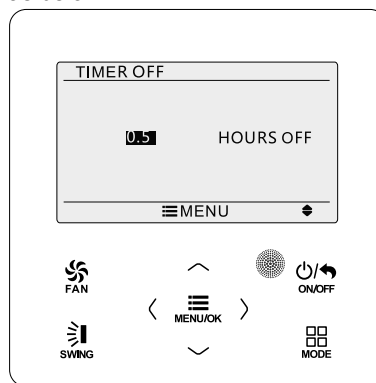

Figure 4-18 Countdown timer off

If timer function is turned on, the set hours will decrease as the unit operation time increases. In this case, residual hours can be viewed after entering timer setting page. This timer function will be executed for only once and then it will be cancelled automatically.

Note :

If this timer function is turned on, when the unit is turned on or turned off, this timer function will be cancelled automatically.

4.11 Clock Setting

4.11.1 Time Format Setting

The user can set the time format in 12-hour system or 24-hour system. Select clock symbol in menu page and then press "MENU/OK" button to enter clock setting page. Press "∧" or "∨" button to select time format and then press "<" or

“>” button to select 12-hour system or 24-hour system. Please refer to the Fig. as below.

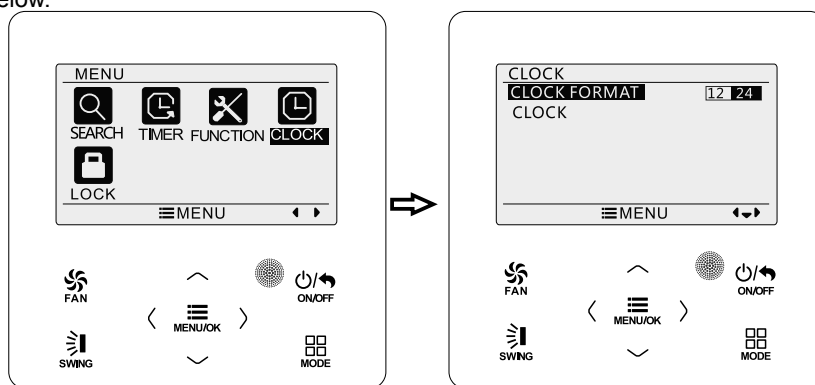

Figure 4-19 Time format selection

4.11.2 Clock Setting

Select clock symbol in menu page and then press “MENU/OK” button to enter clock setting page. Press “^” or “v” button to select time set and then press “MENU/OK” button to enter into time setting page.

Press “<” or “>” button to select setting items: hour, minute, year, month, day; press “^” or “v” button to set the value and then press “MENU/OK” button to save setting. Please refer to the Fig. as below.

Wired Controller

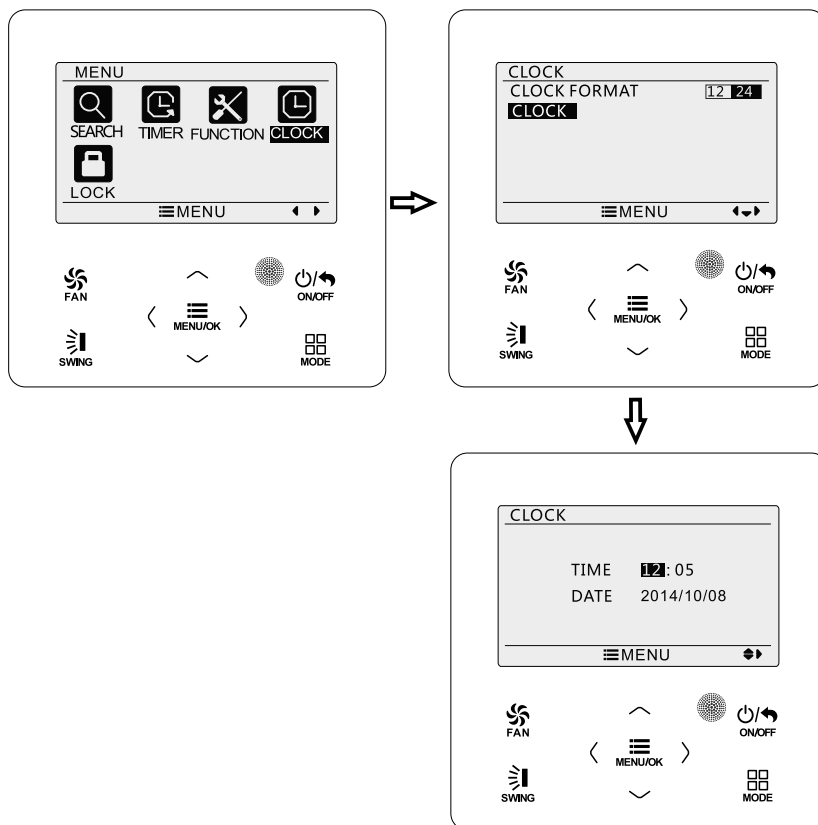

Figure 4-20 Clock setting

4.12 Lock Setting

Select lock symbol in menu page and then press “MENU/OK” button to enter into the lock setting page. Press “^” or “v” button to select the item to be locked and then press “<” or “>” button to lock or unlock. Please refer to the Fig. as below.

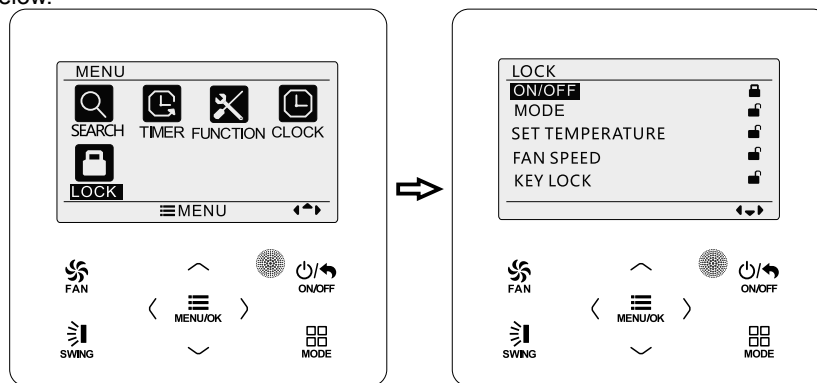

Figure 4-21 Lock setting

Items can be locked: ON/OFF, mode setting, temperature setting, fan speed setting, key lock. Once locking is finished, the corresponding item cannot be set through buttons.

If the keys are locked, all keys cannot be operated after returning to the main page. Please unlock according to the instructions on main page. During unlocking, press “MENU/OK” button, press “<” button and then press “>” button to unlock keys.

5 Installation Instructions

5.1 Parts and Dimension of Wired Controller

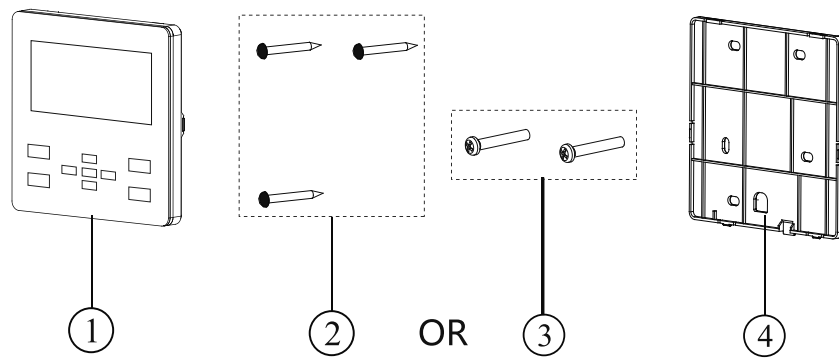
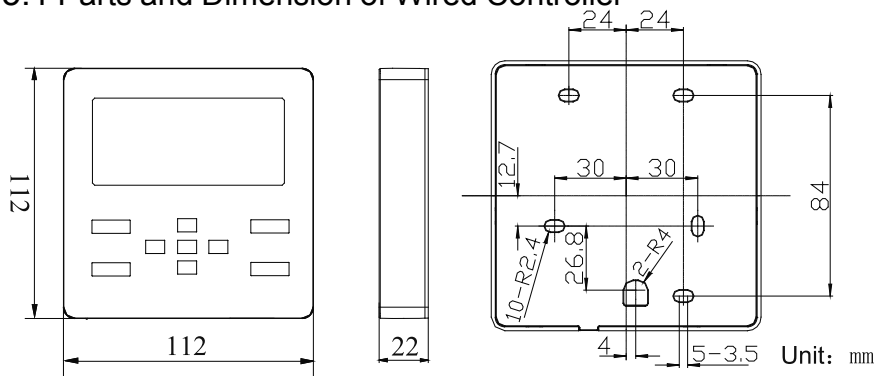

Table 5.1.1 Standard parts

No.	1	2	3	4
Name	Panel of wired controller	Tapping screw ST3.9X25 MA	Screw M4×25	Soleplate of wired controller
Quantity	1	3	2	1

5.2 Installation Requirements

- (1) Prohibit installing the wired controller at wet places.
- (2) Prohibit installing the wired controller at the places with direct sunshine.
- (3) Prohibit installing the wired controller at the place near high temperature objects or water-splashing places.
- (4) Select proper signal wire of wired controller: two-core signal wire (wire diameter \geq 0.75mm; length $<$ 30m;suggested length is 8m) .

5.3 Installation Methods

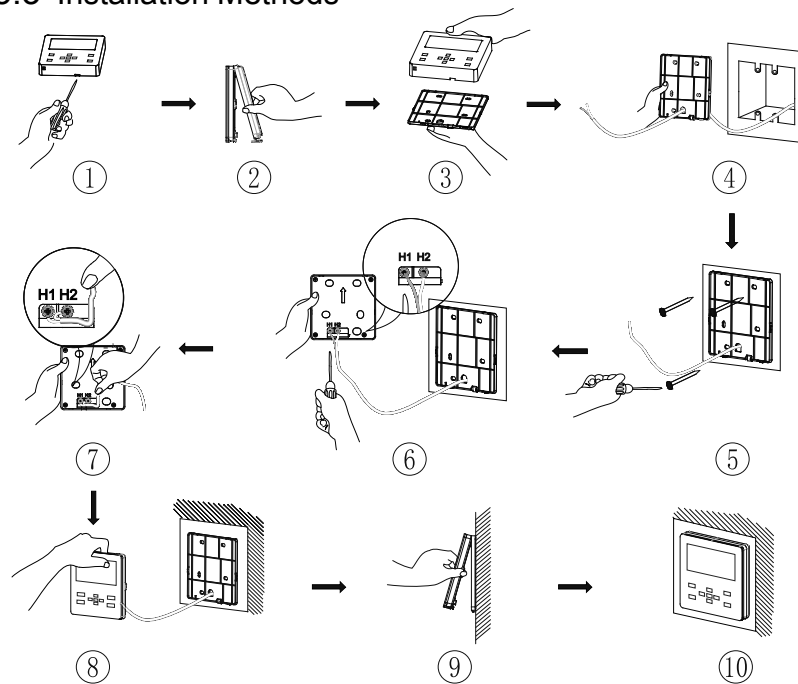

Figure 5-3 Installation diagram for wired controller

The above Fig. is the simple installation process of wired controller; please pay attention to the following items:

- (1) Before installation, please cut off the power for indoor unit.

- (2) Pull out the 2-core twisted pair wire from the installation hole on wall, and pull this wire through the “∩” hole at the rear side of the soleplate of wired controller
- (3) Stick the soleplate of wired controller on the wall and then use tapping screw ST3.9X25 MA or screw M4×25 to fix soleplate and installation hole on wall together.
- (4) Connect two-core twisted pair wire to H1 and H2 wiring column and then fix the screws.
- (5) Tidy up the wires at the back wire groove of panel and bundle the front panel of wired controller to its soleplate.

Note :

If the procedures in point 2 and point 5 mentioned above is hard to be done as the diameter of selected communication wire is big, please peel off the sheathed layer in appropriate length according to actual situation.

5.4 Disassembly

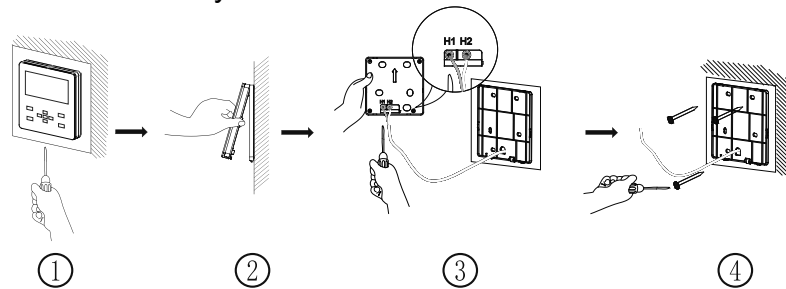

Figure 5-4 Disassembly diagram for wired controller



improve your life

www.argoclima.com